

# PRODUCT DATA SHEET

## 16mm DIAMETER LED SIGNAL



### DESCRIPTION

The range uses screw terminals with wire guards for ease of installation and the ability to daisy chain lights into a string. It offers light diffusion in various colors for easy application in different environments.

### FEATURES

- Shockproof, low power consumption, long life and cool operation.
- Utilizes an ultra-bright LED that is not sensitive to external light.
- Diffused light provides high visibility and more.

# PRODUCT DATA SHEET

## 16mm DIAMETER LED SIGNAL

### SECTIONS AND DIMENSIONS

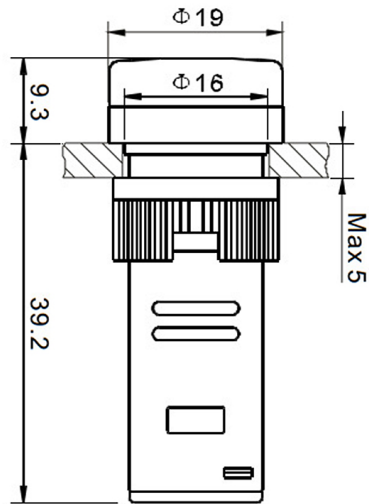

PRODUCT CODE	DİAMETER (mm)	DESCRIPTION	COLOUR
16 - 24V - Y	16	Led Signal 24V AC-DC	Green